

INGRESS PROTECTION:IP67

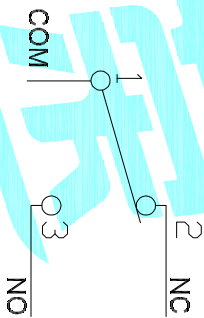

Circuit Diagram

- NOTE:
1. Rating:DC12V 3A
  2. Operating force:130gf MAX
  3. Mechanical Life:500,000

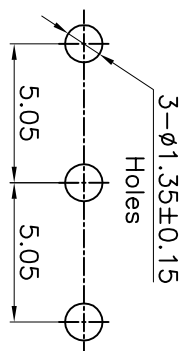
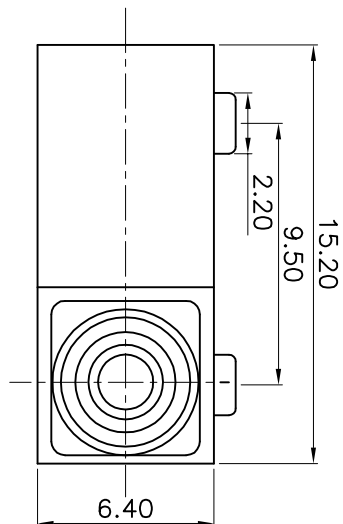
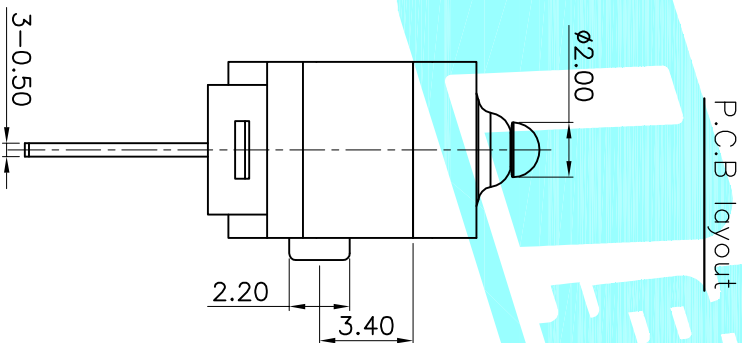
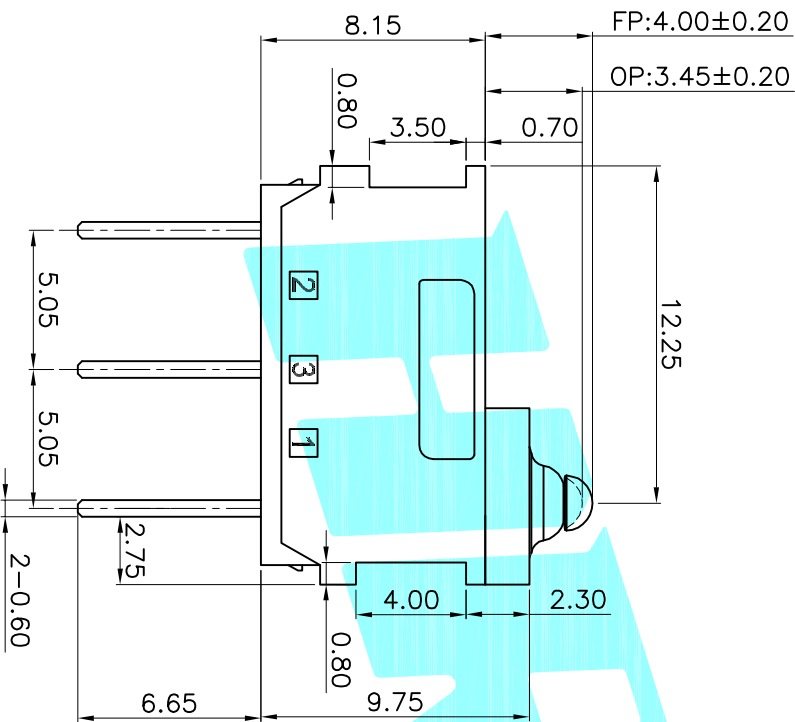

ITEM	PART NAME	TER'NO.	QTY.	MATERIAL	FINISHING	REMARK
⑦	Shrapnel	—	1	Brass	—	—
⑥	Contact	—	1	Ag	—	—
⑤	Sealed Circle	—	1	Silicone Rubber	—	—
④	Terminal	—	3	Brass(0.50t)	Plating silver	—
③	Plunger	—	1	POM	White	—
②	Cose	—	1	PA	White	—
①	Cover	—	1	PA	Black	—

APPROVALS	DATE	TITLE
DRAWN	J.X.Zhang	2018/8/1
CHECKED		
APPROVALS		

APPROVALS	DATE	TITLE
DRAWN	J.X.Zhang	2018/8/1
CHECKED		
APPROVALS		

APPROVALS	DATE	TITLE
DRAWN	J.X.Zhang	2018/8/1
CHECKED		
APPROVALS		

ECN NO.	REV.	DATE.	DESCRIPTION.	CHANGE.	CHECK.	APPRO.
	A		NEW			

APPROVALS	DATE	TITLE
DRAWN	J.X.Zhang	2018/8/1
CHECKED		
APPROVALS		

APPROVALS	DATE	TITLE
DRAWN	J.X.Zhang	2018/8/1
CHECKED		
APPROVALS		

APPROVALS	DATE	TITLE
DRAWN	J.X.Zhang	2018/8/1
CHECKED		
APPROVALS		

APPROVALS	DATE	TITLE
DRAWN	J.X.Zhang	2018/8/1
CHECKED		
APPROVALS		

APPROVALS	DATE	TITLE
DRAWN	J.X.Zhang	2018/8/1
CHECKED		
APPROVALS		

APPROVALS	DATE	TITLE
DRAWN	J.X.Zhang	2018/8/1
CHECKED		
APPROVALS		

APPROVALS	DATE	TITLE
DRAWN	J.X.Zhang	2018/8/1
CHECKED		
APPROVALS		

APPROVALS	DATE	TITLE
DRAWN	J.X.Zhang	2018/8/1
CHECKED		
APPROVALS		

APPROVALS	DATE	TITLE
DRAWN	J.X.Zhang	2018/8/1
CHECKED		
APPROVALS		

APPROVALS	DATE	TITLE
DRAWN	J.X.Zhang	2018/8/1
CHECKED		
APPROVALS		

APPROVALS	DATE	TITLE
DRAWN	J.X.Zhang	2018/8/1
CHECKED		
APPROVALS		

APPROVALS	DATE	TITLE
DRAWN	J.X.Zhang	2018/8/1
CHECKED		
APPROVALS		

APPROVALS	DATE	TITLE
DRAWN	J.X.Zhang	2018/8/1
CHECKED		
APPROVALS		

APPROVALS	DATE	TITLE
DRAWN	J.X.Zhang	2018/8/1
CHECKED		
APPROVALS		

APPROVALS	DATE	TITLE
DRAWN	J.X.Zhang	2018/8/1
CHECKED		
APPROVALS		

APPROVALS	DATE	TITLE
DRAWN	J.X.Zhang	2018/8/1
CHECKED		
APPROVALS		

APPROVALS	DATE	TITLE
DRAWN	J.X.Zhang	2018/8/1
CHECKED		
APPROVALS		

APPROVALS	DATE	TITLE
DRAWN	J.X.Zhang	2018/8/1
CHECKED		
APPROVALS		

APPROVALS	DATE	TITLE
DRAWN	J.X.Zhang	2018/8/1
CHECKED		
APPROVALS		

APPROVALS	DATE	TITLE
DRAWN	J.X.Zhang	2018/8/1
CHECKED		
APPROVALS		

APPROVALS	DATE	TITLE
DRAWN	J.X.Zhang	2018/8/1
CHECKED		
APPROVALS		

APPROVALS	DATE	TITLE
DRAWN	J.X.Zhang	2018/8/1
CHECKED		
APPROVALS		

APPROVALS	DATE	TITLE
DRAWN	J.X.Zhang	2018/8/1
CHECKED		
APPROVALS		

APPROVALS	DATE	TITLE
DRAWN	J.X.Zhang	2018/8/1
CHECKED		
APPROVALS		

APPROVALS	DATE	TITLE
DRAWN	J.X.Zhang	2018/8/1
CHECKED		
APPROVALS		

APPROVALS	DATE	TITLE
DRAWN	J.X.Zhang	2018/8/1
CHECKED		
APPROVALS		

APPROVALS	DATE	TITLE
DRAWN	J.X.Zhang	2018/8/1
CHECKED		
APPROVALS		

APPROVALS	DATE	TITLE
DRAWN	J.X.Zhang	2018/8/1
CHECKED		
APPROVALS		

APPROVALS	DATE	TITLE
DRAWN	J.X.Zhang	2018/8/1
CHECKED		
APPROVALS		

APPROVALS	DATE	TITLE
DRAWN	J.X.Zhang	2018/8/1
CHECKED		
APPROVALS		

APPROVALS	DATE	TITLE
DRAWN	J.X.Zhang	2018/8/1
CHECKED		
APPROVALS		

APPROVALS	DATE	TITLE
DRAWN	J.X.Zhang	2018/8/1
CHECKED		
APPROVALS		

APPROVALS	DATE	TITLE
DRAWN	J.X.Zhang	2018/8/1
CHECKED		
APPROVALS		

APPROVALS	DATE	TITLE
DRAWN	J.X.Zhang	2018/8/1
CHECKED		
APPROVALS		

APPROVALS	DATE	TITLE
DRAWN	J.X.Zhang	2018/8/1
CHECKED		
APPROVALS		

APPROVALS	DATE	TITLE
DRAWN	J.X.Zhang	2018/8/1
CHECKED		
APPROVALS		

APPROVALS	DATE	TITLE
DRAWN	J.X.Zhang	2018/8/1
CHECKED		
APPROVALS		

APPROVALS	DATE	TITLE
DRAWN	J.X.Zhang	2018/8/1
CHECKED		
APPROVALS		

APPROVALS	DATE	TITLE
DRAWN	J.X.Zhang	2018/8/1
CHECKED		
APPROVALS		

APPROVALS	DATE	TITLE
DRAWN	J.X.Zhang	2018/8/1
CHECKED		
APPROVALS		

APPROVALS	DATE	TITLE
DRAWN	J.X.Zhang	2018/8/1
CHECKED		
APPROVALS		

APPROVALS	DATE	TITLE
DRAWN	J.X.Zhang	2018/8/1
CHECKED		
APPROVALS		

APPROVALS	DATE	TITLE
DRAWN	J.X.Zhang	2018/8/1
CHECKED		
APPROVALS		

APPROVALS	DATE	TITLE
DRAWN	J.X.Zhang	2018/8/1
CHECKED		
APPROVALS		

APPROVALS	DATE	TITLE
DRAWN	J.X.Zhang	2018/8/1
CHECKED		
APPROVALS		

APPROVALS	DATE	TITLE
DRAWN	J.X.Zhang	2018/8/1
CHECKED		
APPROVALS		

APPROVALS	DATE	TITLE
DRAWN	J.X.Zhang	2018/8/1
CHECKED		
APPROVALS		

APPROVALS	DATE	TITLE
DRAWN	J.X.Zhang	2018/8/1
CHECKED		
APPROVALS		

APPROVALS	DATE	TITLE
DRAWN	J.X.Zhang	2018/8/1
CHECKED		
APPROVALS		

APPROVALS	DATE	TITLE
DRAWN	J.X.Zhang	2018/8/1
CHECKED		
APPROVALS		

APPROVALS	DATE	TITLE
DRAWN	J.X.Zhang	2018/8/1
CHECKED		
APPROVALS		

APPROVALS	DATE	TITLE
DRAWN	J.X.Zhang	2018/8/1
CHECKED		
APPROVALS		

APPROVALS	DATE	TITLE
DRAWN	J.X.Zhang	2018/8/1
CHECKED		
APPROVALS		

APPROVALS	DATE	TITLE
DRAWN	J.X.Zhang	2018/8/1
CHECKED		
APPROVALS		

APPROVALS	DATE	TITLE
DRAWN	J.X.Zhang	2018/8/1
CHECKED		
APPROVALS		

APPROVALS	DATE	TITLE
DRAWN	J.X.Zhang	2018/8/1
CHECKED		
APPROVALS		



APPROVALS	DATE	TITLE
DRAWN	J.X.Zhang	2018/8/1
CHECKED		
APPROVALS		

APPROVALS	DATE	TITLE
DRAWN	J.X.Zhang	2018/8/1
CHECKED		
APPROVALS		

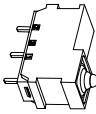
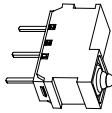
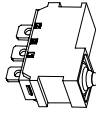
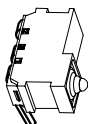
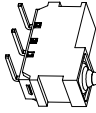
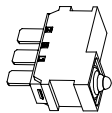
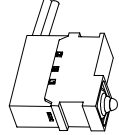
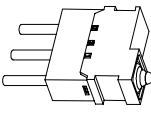
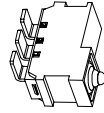
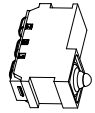
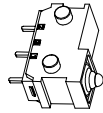
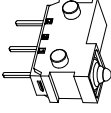
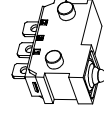
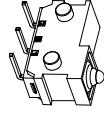
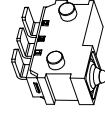
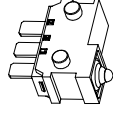
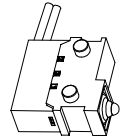
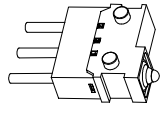
APPROVALS	DATE	TITLE
DRAWN	J.X.Zhang	2018/8/1
CHECKED		
APPROVALS		

						
A	B	C	D	E	F	G
						
H	I	J	K	L	M	N
						
O	P	Q	R			

NO. : 1

APPROVALS		DATE		 ELECTRONICS CO.,LTD			
DRAWN	J.X.Zhang		2018/8/1				
CHECKED				TITLE: MICRO SWITCHS			
APPROVALS				PART NO. K9-1802□			
TOLERANCES ARE		30 <sup>±0.15</sup>	±0.30	ANGLE			
		10 <sup>±0.10</sup>	±0.20		UNIT: mm		
		5 <sup>±0.05</sup>	±0.15	±2°	SCALE: 1:1		
		~ 5	±0.10		PROJ. 		
ECN NO.	REV.	DATE.	CHANGE.	CHECK.	APPRO.	DRAWING NO.	SHEET 1 OF 1
	A						
DESCRIPTION.						NEW	